



**PMSM HVLS FAN**

## ABOUT US

RR Global, a USD 1.25 Billion conglomerate is one of the most prominent names in the electrical industry. With innovation being at the core of our offerings, we cater to a varied range of product categories including Cables & Wires, LED Lighting, Switches, Switchgears, HVLS Fans & more. We have grown exponentially over the past four decades and are today present in more than 90 countries. Innovation is one of our prominent brand ethos. All our products are of the highest international quality standards and are internationally certified with IEC, CE, CB, Intertek to name a few.

RR Global's vast range of products, cutting-edge technology, and international quality caters products to every industry and every market. With our products, we always strive to create a safe and reliable environment for our customers. Our brand ethos of quality, innovation, and trust makes us the trusted choice for customers not only in India but across the globe.

## CONCEPT

The air produced from a HVLS fan moves towards the floor in a column that radiates in all direction, flowing horizontally until it reaches a wall – or the airflow from another fan – at which stage the air flow turns upwards and flows back towards the fan. This creates convection like air current that builds as the fan continues to spin. The increased air circulation effectively removes hot, humid air and replaces it with drier air. This process allows for a complete mixing of air in the atmosphere resulting in perceived temperature drop of 3 to 5 degrees, depending on the season.

## RR PMSM HVLS FAN

Permanent Magnet Synchronous Motorised (PMSM) HVLS Fan series from RR has been conceptualized and developed at our in-house R&D centre. It has a light and stylish design with the fan blades made from aviation grade aluminum that makes them stronger and more efficient. The winglets help in reducing air resistance and noise, reaching optimal silent performance at low speeds. Our PMSM HVLS Fan is certified with ISO 9001:2015 and made using only world class industrial grade components and spare parts of the highest quality. We ensure the most efficient and reliable fan for you to use.



RR-V05 DECORATIVE-66"



RR-V05 DECORATIVE-100"



CONTROL PANELS V05



CONTROL PANELS V06



RR-V05 L(8'-12')









RR-V05 H(8'-12')



RR-V06 (16'-24')



# ADVANTAGES OF RR PMSM HVLS FANS (GEARLESS) OVER GEARED HVLS FANS

					
INHOUSE MANUFACTURING	LIGHT WEIGHT	SILENT DESIGN	PMSM MOTOR	ENERGY SAVING	MAINTENANCE FREE

## TECHNICAL SPECIFICATION

RR BLDC / PMSM HVLS FANS											
MODEL	RR-V05 DECORATIVE	RR-V05 DECORATIVE	RR-V05 L-8	RR-V05 L-10	RR-V05 L-12	RR-V05 H-8	RR-V05 H-10	RR-V05 H-12	RR-V06 R-16	RR-V06 R-20	RR-V06 R-24
Diameter	66 Inch	100 Inch	8 Feet	10 Feet	12 Feet	8 Feet	10 Feet	12 Feet	16 Feet	20 Feet	24 Feet
Input Power	SINGLE PHASE 230 VOLT, 50 HZ										
No. of Blade	8	6	5	5	5	5	5	5	5	5	5
Blade Material	ABS	ABS	AVIATION GRADE EXTRUDED ALUMINIUM ALLOY 6063-T								
Approximate Fan Weight [kg]	12	15	32	33	35	45	53	54	84	89	95
Power [W]	60	65	120	175	190	150	200	400	700	1000	1300
Max. RPM	115	100	140	120	110	110	100	95	80	65	55
Sound Level of Motor	≤30	≤30	≤40	≤40	≤40	≤40	≤40	≤40	≤45	≤45	≤45
Motor Colour	White/Brown/Black	White/Brown/Black	Black	Black	Black	Black	Black	Black	Black	Black	Black
Blade Colour	White/Brown/Black	White/Brown/Black	Black	Black	Black	Siemens Grey	Siemens Grey	Siemens Grey	Siemens Grey	Siemens Grey	Siemens Grey

## SAFETY & CONCEPT OF RR PMSM HVLS

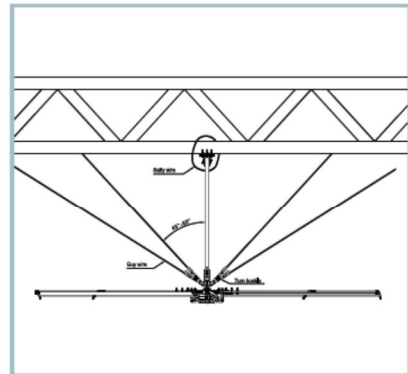
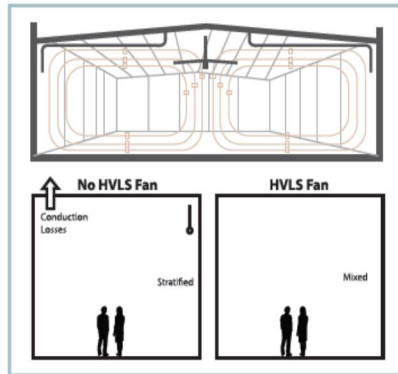
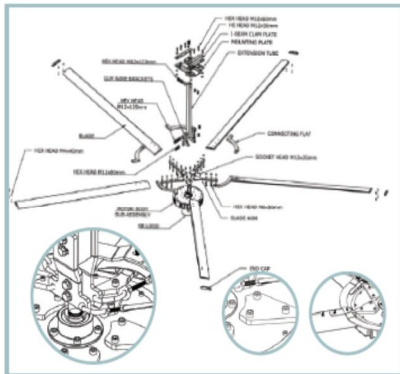

ROUND PIPE MOUNTING



I-BEAM MOUNTING













SQUARE PIPE MOUNTING



RCC MOUNTING

## APPLICATIONS

									
MANUFACTURING UNITS	SHOPPING MALL	RAILWAY TERMINALS	RELIGIOUS TERMINALS	COW SHEED /POULTRY	BUS TERMINALS	WARE HOUSE	FOOD COURT	AIR PORT	GYMNASIUM



Perfect Airconditioning Trading Company  
A-269 Okhla Industrial Area-I, New Delhi-110020  
Tel: 01126817098,26817099,26811831,26811832,41811832  
email: [ac@tripti.in](mailto:ac@tripti.in) website: [www.tripti.in](http://www.tripti.in)

---

**R R KABEL LIMITED**

**Regd. Office :** Ram Ratna House, Utopia City, P. B. Marg, Worli, Mumbai - 400 013.

**T:** +91 - 22 - 2494 9009 / 2492 4144 • **F:** +91 - 22 - 2491 2586 • **E:** [mumbai.rrkabel@rrglobal.com](mailto:mumbai.rrkabel@rrglobal.com)

Survey No. 142/2, Madhuban Dam Road, Rakholi, Village Karad, Silvassa - 396240. India.

**T:** +91 - 7228 012 928 • **E:** [hvls.support@rrglobal.com](mailto:hvls.support@rrglobal.com)

**[www.rrglobal.com](http://www.rrglobal.com)**

---

The information & technical data mentioned in this brochure is true, complete and correct. However, the technical data could vary from time to time, hence, current details should always be checked with RR Global for accuracy.